

Actual Size: 26" x 45" x 39" • (66.04cm x 114.3cm x 99.06cm)

Shipping Size: 28" x 48" x 49" • (71cm x 122cm x 124cm)

Net Weight: 210lbs • (95.3kg)

Shipping Weight: 280 lbs • (127kg)

Seat Width: 20" • (50.8cm)

Unoccupied Water Capacity: 75gal • (284L)

Occupied Water Capacity: 35-55gal • (125 - 208L)

Included Features (Soaking)

1. Acrylic shell gloss white finish fiberglass gelcoat reinforced
2. Stainless steel frame with adjustable leveling legs
3. Custom crafted industrial plastic composite outward swing door with tempered glass
4. Removable front apron with two access panels (seat side)
5. One reversible end panel for left or right corner installation options
6. Stainless steel chrome finish U-shape wall-mounted grab bar
7. Single 2" Drain with an emergency pull up chain, consisting of two 2" outlets and an overflow

Jetting & Therapy Options

1. Air + Hydro (LED Chromatherapy Light Included)
2. Hydro + Hydro Independent Foot Massage (LED Chromatherapy Light Included) * (2)
3. Hydro Massage + Microbubble (LED Chromatherapy Light Included)
4. Hydro Massage (LED Chromatherapy Light Not Included)
5. Soaking



Jetting & Therapy Systems

Hydro Massage

- Hydro Massage Pump 7A
- Intensity Dial Air Control
- Ozone Sterilization 0.04A
- 15 jets (9 Seat Jets 6 Foot Jets)
- On/Off Push Control
- In-line Water Heater 6A 650W

Hydro + Hydro Foot Massage * (2)

- 2 Hydro Massage Pumps 5A + 7A
- 2 Intensity Dial Air Controls
- Ozone Sterilization 0.04A
- 15 jets (9 Seat Jets 6 Foot Jets)
- On/Off Push Control
- In-Line Water Heater 6A 650W

2 Piece Faucet

- Up to 16GPM @ 60PSI (at ideal in-home plumbing conditions)
- Two 5' Water Supply Lines 3/4"
- Pull out Hand Shower in Chrome Finish with a 5' Retractable Stainless Steel Braided Hose

Air Massage

- Air Massage Pump 4.5A 500W
- 3 Speed Pump
- Auto-purge (Activates 20 minutes after pump shutdown)
- 16 jets (8 Seat Jets 6 Foot Jets 2 Calf Jets)
- On/Off push control

Microbubble Therapy

- 1 HP Pump 7.3A
- Pressure Vessel
- On/Off push control
- Agitator Valve

Optional Features

1. Heated Seat and Backrest
2. Digital Controller

Electrical Requirements

Dedicated GFCI protected electrical line(s) required 110/120V 60Hz

Warranty

- Lifetime limited* warranty on shell, frame, door, and parts to original purchaser/Address
- Labor or installation is not covered - please refer to the Ella warranty certificate
- Non Ella brand faucets covered under manufacturers original warranty

Note: LED Chromatherapy light .04AMP with On/Off push control is included with the following dual packages: Hydro + Air, Hydro + Micro, Hydro + Hydro

Disclaimer*: AMP value for each pump may change based on availability. Please verify before purchase. (800.480.6850)

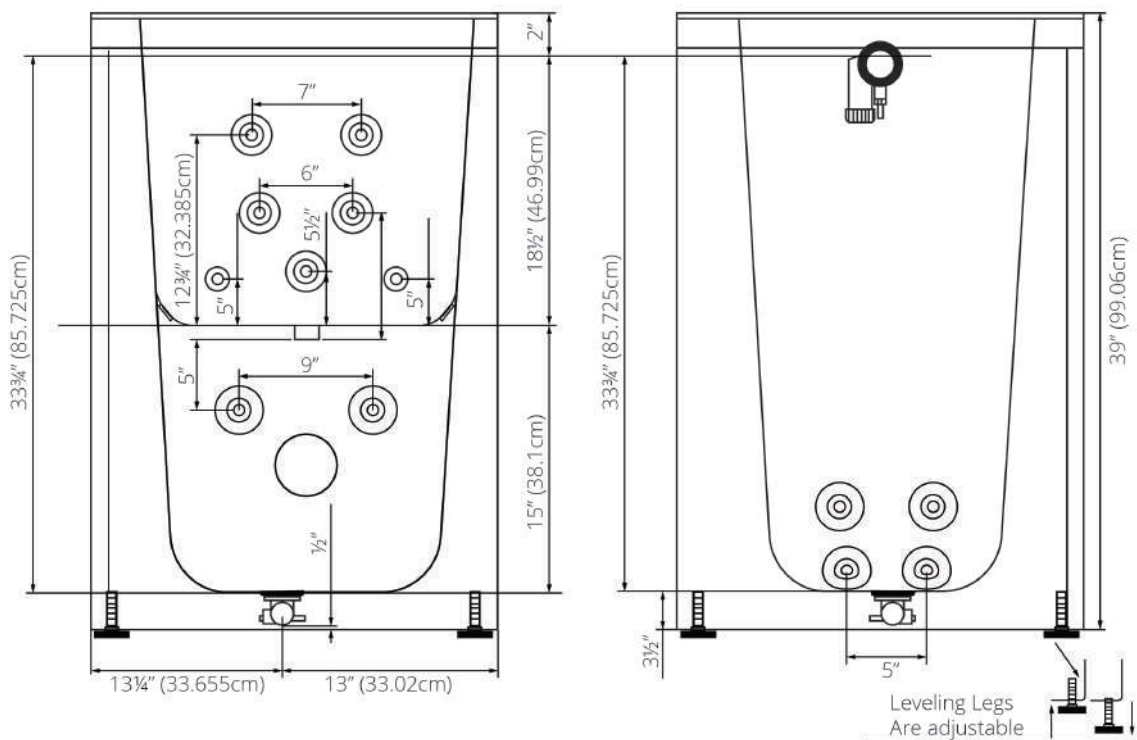
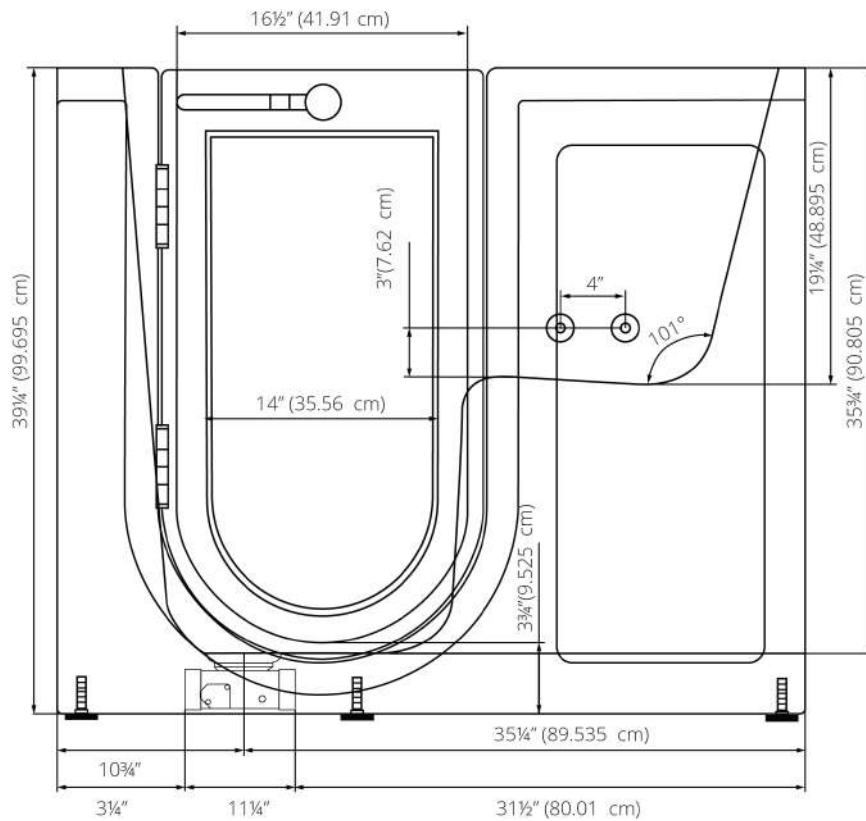

Ella 2" T-Type Single Port Floor Drain (One Drain Included)

2" T-type Dual Port Floor Drain for
Ella Dual Drain Walk-In Bathtubs

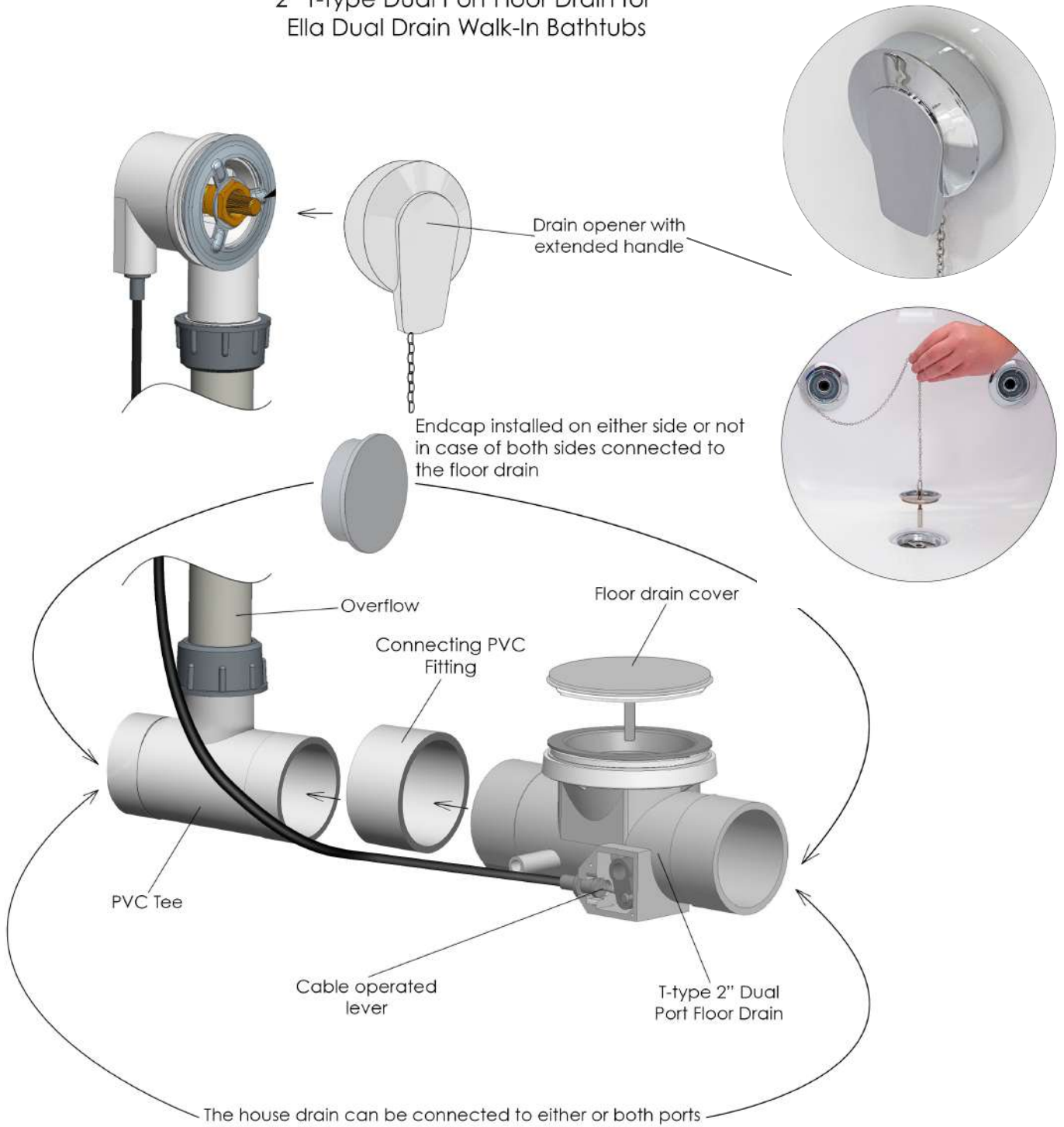

Two 3/4" connector water supply lines included with Ella Fast Fill Faucets
Connect to Shut Off Valves (not included)



All electrical fixtures connect to a dedicated GFCI protected outlet or GFCI protected Circuit Breaker.



Images below show examples of PVC pipe connections (not included). Reducers can be used to connect smaller drain pipes.

T-Type four (4) 2" drain ports allow for the drain pipe to be installed in either direction.

Drain Caps Installed On Either Side Of The Drain unused Port.

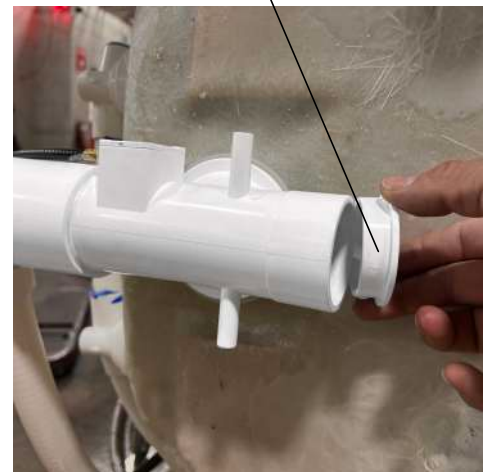

Description

Solid brass spout chrome finish single lever high flow bathtub faucet with diverter button Two (2) 3/4" 5' braided stainless- steel supply lines. Pull out hand shower mixer with back-flow prevention valve 5 settings and 5' braided hose in a Chrome or Brushed Nickel finish.

Flow

- Hand shower is limited to 1.9 GPM (7.5L/min)
- Faucet fill rate designed for 16 GPM (68.1L/min)

Cartridge

- 40mm high flow cartridge design
- Nonmetallic/nonferrous and stainless-steel material

Standards

- Third party certified to meet: CSA B125.1, ASMEA112.18.1, ICC117.1 and all applicable requirements referenced therein
- Certified to ANSI/NSF 61/9
- ADA for lever/handle
- IAPMO R&T UPC certified



NOTE: This faucet is designed to be installed through 2-1/2" diameter hole for faucet, 1/3" diameter hole for mounting rods, and a 7/8" diagonal hole for the hand shower.

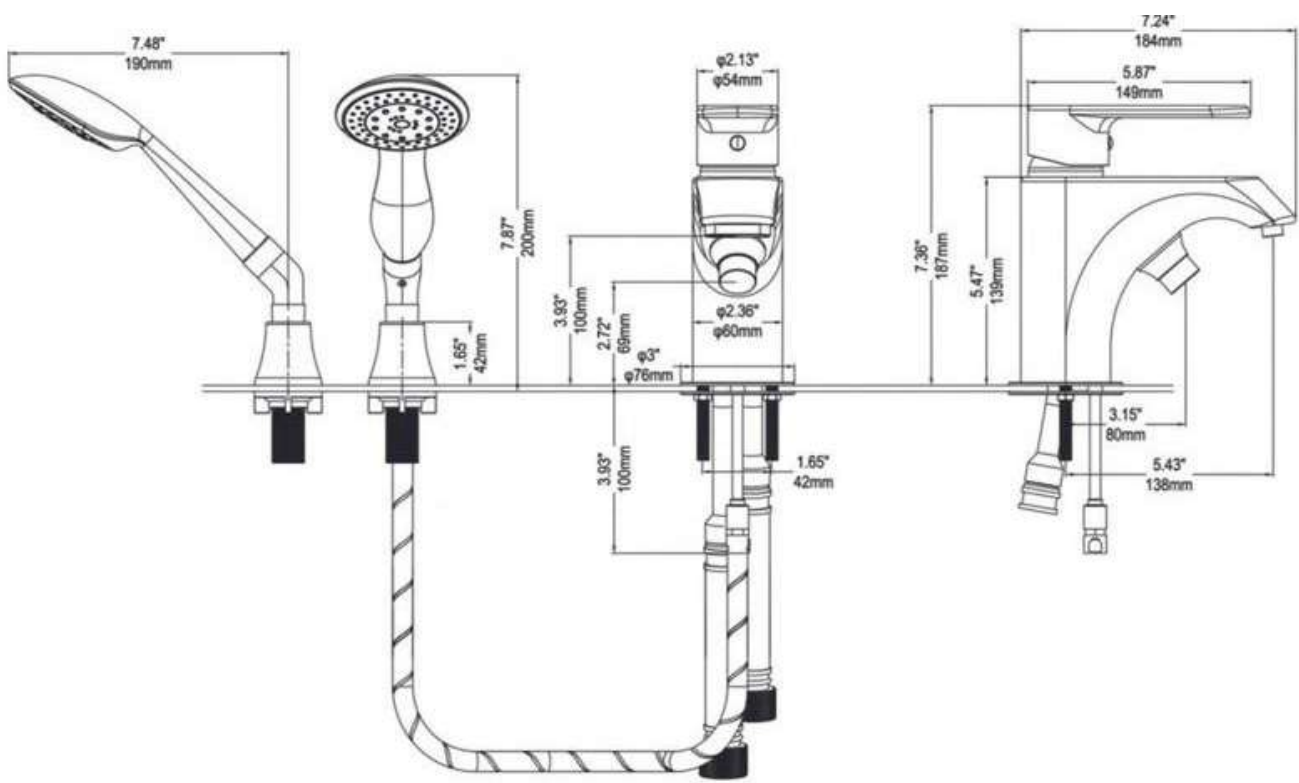

Step-by-step Instructions to replace a valve cartridge for Ella 2-piece faucets.

Step.1 Remove the Hot/Cold screw hole cover.

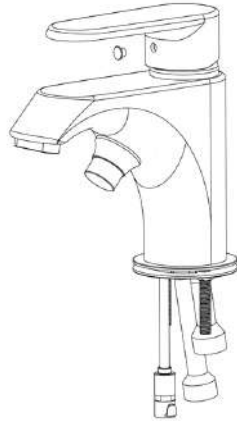

Step.2 Use an Allen wrench to remove the handle Screw.



Step.3 Take out the handle and remove the brass escutcheon

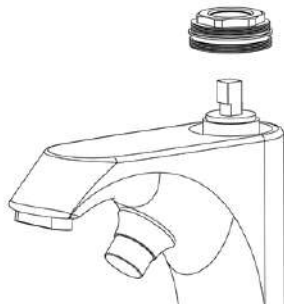

Step.4 Use a wrench to unscrew the pressure cap.

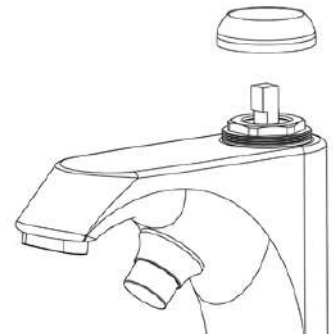

Step.5 Remove the cartridge and replace it with new piece.

